

GEAR PUMP: SILENCER SMART 250 ML/MIN – BLDC MOTOR & INTEGRATED MOTOR CONTROL



The Silencer series is everything a gear pump should be: **durable, leak-free, reliable, chemically inert and quiet.**

It's manifold mounting simplifies the plumbing and reduces the installed cost in your system. A magnetic coupling ensures the pump will never leak and high quality wetted materials are chosen to withstand a wide range of aggressive chemicals. The smart gear and shaft-bearing design will optimize your fluid handling system. The integrated motor controller with conformal coating for splash protection, makes system integration easy. **The Silencer series - Engineering Your Flow.**

- > Life Science Analytical – Diagnostics
- > Bulk & Sample Fluid Transfer
- > Fully Automated Coffee Machines
- > Continuous Ink Jet Printing

Benefits



Low Noise: Thanks to intelligent design and selected components, our pumps are some of the quietest of their kind. This makes them unbeatable when it's important to have peace and quiet.



Long Life: DPP pumps are all characterized by their robustness and performance. Wear and tear is at its lowest, and their smart designs ensure a sustainable reduction of operating costs.



100% Outgoing Test: Before any pump leaves our factory, it is stringently and extensively tested in accordance with its specifications. Our customers receive detailed reports, saving them time and money.



Chemically Resistant: Our pumps are made from materials that are resistant to a wide range of aggressive chemicals. This means our pumps can also operate reliably and precisely in even the most environments.



Low Pressure Pulsation: Thanks to their smart drives and the innovative helical gear design our pumps ensure an extremely smooth fluid delivery with almost no pressure pulsation.



No Shaft-Seals: DPP gear pumps are hermetically sealed instead of using conventional shaft seals. This means low maintenance for you and your customers, a long service life and the highest degree of productivity.

Specifications

Performance

Max. continuous pressure:	5 bar
Max. intermittent pressure:	6 bar
Max. static Case pressure:	20 bar
Inlet:	Self-priming
Speed range:	300-4600 rpm
Fluid viscosity range:	0.3 to 1000 cps

Electrical

Supply voltage:	24 vdc
Rotation:	Uni-directional
BLDC controller:	Integrated on motor
Max. current:	1.6 amps
Mating Connector:	TE 104257-4 Housing TE 1-104480-4 Contacts

Temperature

Fluid temperature range:	0-80°C
Ambient air temp. range:	0-60°C
Relative humidity range:	0-95% non-condensing

Construction

Standard:	316L or 303 stainless steel (body), PEEK® (gears), EPDM (o-ring)
Optional:	PPS (gears), Teflon®, Silicone, Viton®, Kalrez® (o-rings)
Inlet/Outlet:	Manifold mounted with o-ring glands to fit -008 o-ring Consult factory for options
Marking:	Permanent laser-mark identification for 100% traceability
Mass:	0.5 kg

Performance values are limits and cannot all happen simultaneously.
Please contact your sales engineer for further technical information and customized options.



Engineering Your Flow

Dimensional Outline Drawing (mm)

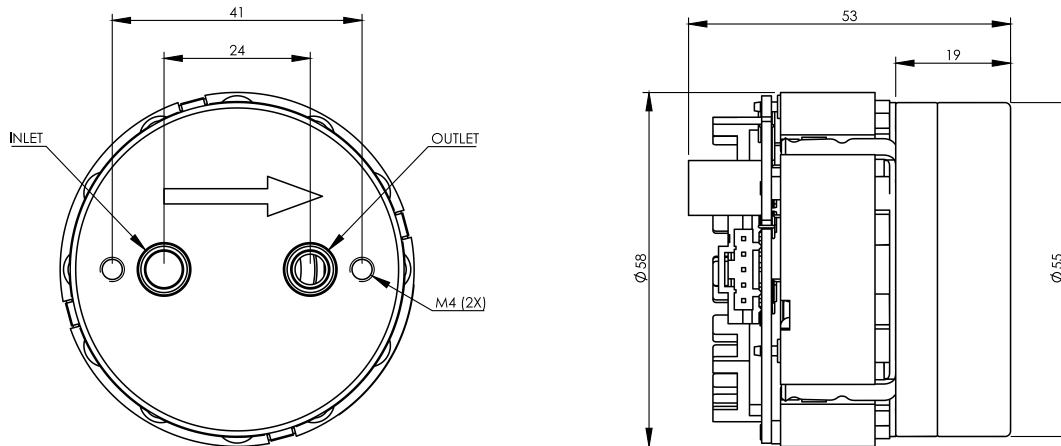

Typical Performance Curve (Water at Room Temperature)

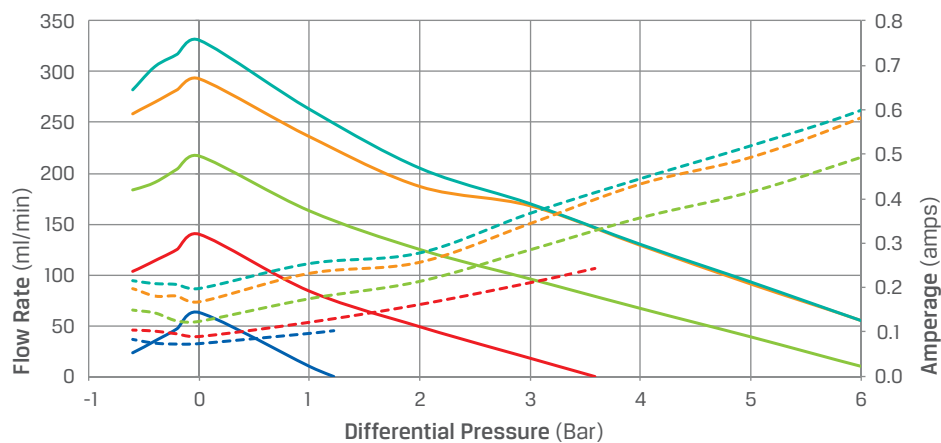

Motor Control Voltage: Amperage (amps)



DPP is certified to medical standard ISO 9001 / ISO 13485 and operates a clean-room according to ISO Class 7. All pumps are customized; the information given represent one of the possibilities.

None of the information supplied by Diener Precision Pumps constitutes a warranty regarding product performance or use. Any information regarding performance or use is only offered as suggestion for investigation for use, based upon Diener Precision Pump's or other customer experience. DPP makes no warranties, expressed or implied, concerning the suitability or fitness of any of its products for any particular purpose. It is the responsibility of the customer to determine that the product is safe, lawful and technically suitable for the intended use. The disclosure of information herein is not a license to operate under, or a recommendation to infringe any patents. All new DPP product developments are tested and confirmed according to the «ROHS Directive».